

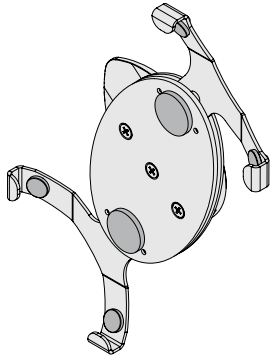

iPad™ IPM-500 Mounting Frame Installation Instructions



The IPM-500 open mounting frame securely holds the Apple iPad™ or iPad2™ (not included) in place and gives access to all iPad™ controls and connections. Its removeable wall mount plate may be installed on any single stud surface, and provides 360° rotation for landscape or portrait placement.



3130 East Miraloma Avenue
Anaheim, CA 92806 USA
USA and Canada
Phone: 1.800.368.9700
Fax: 1.800.832.4888

Other Locations – Phone: (001).714.632.7100; Fax: (001).714.632.1044 ©Premier Mounts 2011

Parts List

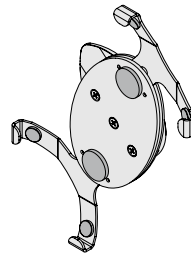

IPM-500
(Qty 1)



#8 x 1 1/4" Wood Screw
(Qty 2)

Step 1

Remove the wall plate from the IPM-500.

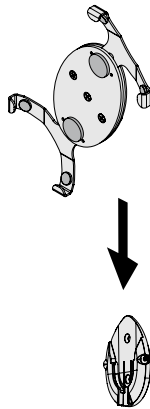

Step 2

Use two (2) #8 x 1 1/4" wood screws to attach the wall plate to a single wood stud.

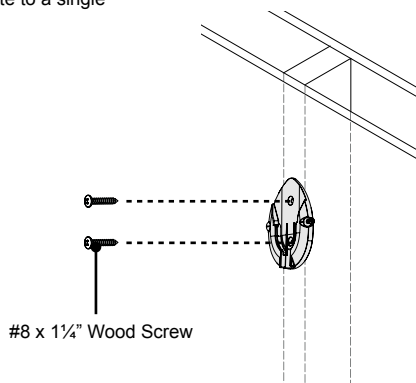

Step 3

? Are you installing an original iPad™ or iPad2™ to the IPM-500?

If an **original iPad™**, remove the corner felt pads on the IPM-500. Then continue to step 4 below.

If an **iPad2™**, continue to step 4 below.

Remove if using original iPad™

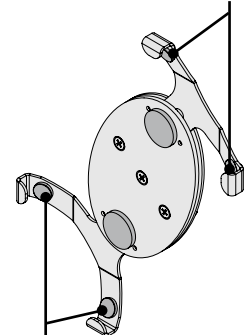

Remove if using original iPad™

Step 4

- 1 Extend the arms of the IPM-500.
- 2 Insert the iPad™ in the IPM-500.

Each arm of the IPM-500 should fit over a corner of the iPad™.

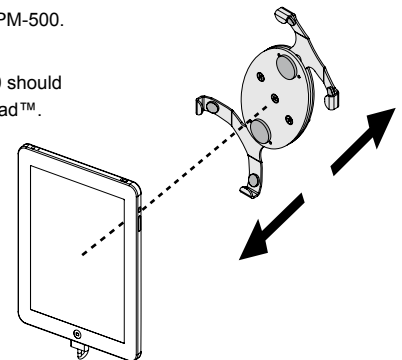

• All trademarks are the property of the respective trademark owners.



IPM-500 Installation Instructions (cont'd)

Step 5

- 1 Adjust the arms on the IPM-500 so that the iPad™ fits snugly inside the mount (Figure 1).
- 2 Tighten the two (2) pre-installed Phillips screws on the back of the IPM-500 to secure the arms (Figure 2).

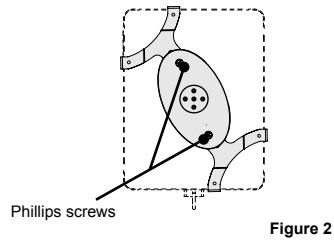
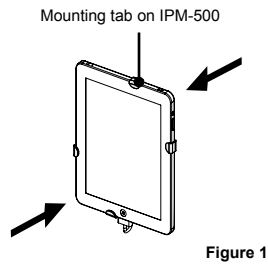

Step 6

- 1 Insert the IPM-500 into the wall plate.
- 2 Rotate the mount to the desired landscape or portrait position.
- 3 Tighten the two (2) pre-installed M4 x 16mm pan combo screws on the sides of the wall plate.

