

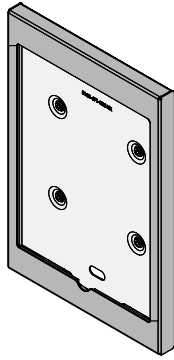

iPad™ IPM-100 Mounting Frame Installation Instructions





The IPM-100 mounting frame securely holds the Apple iPad™ or iPad2™ (not included) in place and prevents access to all control buttons except the home button. It fastens easily to any of Premier Mounts' wall or table mounts (sold separately) using the VESA 100x100mm mounting pattern. The IPM-100 provides flexibility and security for the optimal hands-free experience.



3130 East Miraloma Avenue
Anaheim, CA 92806 USA
USA and Canada
Phone: 1.800.368.9700
Fax: 1.800.832.4888

Other Locations – Phone: (001).714.632.7100; Fax: (001).714.632.1044 ©Premier Mounts 2011

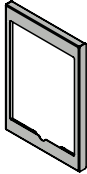
Parts List

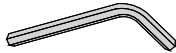
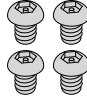
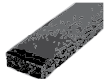
		iPad2™ Kit
		
IPM-100 - Front Piece (Qty 1)	IPM-100 - Back Piece (Qty 1)	Adhesive-Backed Bumper (Qty 8)
		
M5 Security Allen Wrench (Qty 1)	M4 x 8mm Security Screw (Qty 4)	Adhesive Foam Tape (Qty 2)

Step 1

? Are you installing an iPad™ or iPad2™ to the IPM-100?
If an iPad™, skip to step 5 on page 2.
If an iPad2™, continue to step 2 below.

Step 2

Attach two (2) strips of adhesive foam tape to locations "A" inside the front piece.

 Locations "A" are inside the outer edges of the front piece.

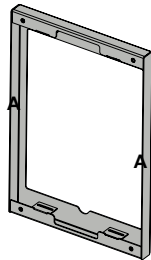

Inside of Front Piece

Step 3

Attach four (4) adhesive-backed bumpers to locations "B" inside the front piece.

 Locations "B" are over the centers of the inside slots.

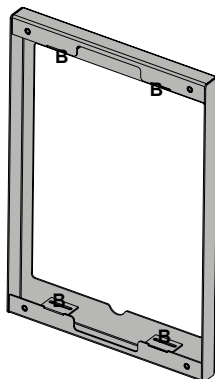

Step 4

Attach four (4) adhesive-backed bumpers to locations "C" on the inside of the back piece.

 Locations "C" are 1½" away from the center of each bump on the back piece.

 Make sure the metal bumps on the back piece are protruding on the opposite side of the adhesive-backed bumpers.

Continue to step 5 on page 2.

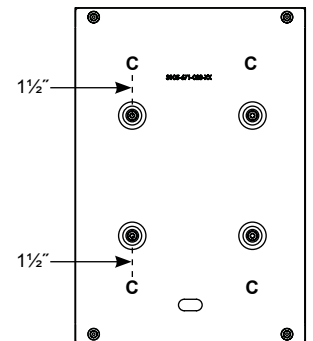

• All trademarks are the property of the respective trademark owners.



Step 5

Attach the dock connector to the iPad™.

Step 6

Place the iPad™ and its attached dock connector into the front piece.

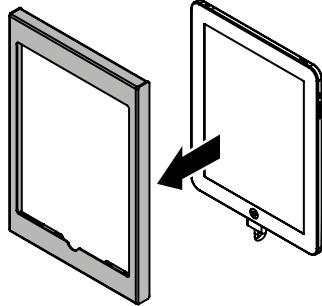

Step 7

Thread the USB end of the dock connector through the slot of the back piece.



Make sure the bumps of the VESA mounting holes on the back piece are facing away from the iPad™.

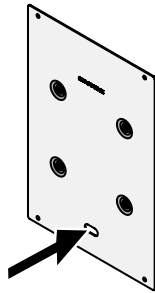

Thread the USB end of the dock connector through this slot.

Step 8

Use the M5 security Allen wrench and four (4) M4 x 8mm security screws to fasten the back piece to the front piece.

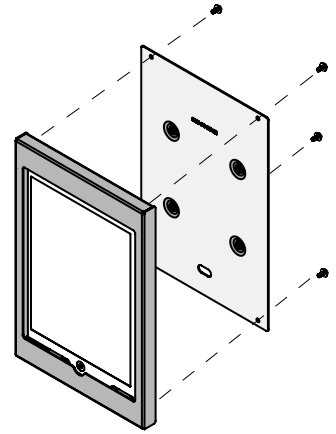

Step 9

Attach the IPM-100 to the desired mount (not included). Refer to the mount's installation manual.